



RECORD THIS UNIT INFORMATION FOR FUTURE REFERENCE:	
Model Number	_____
Serial Number	_____
Date Purchased	_____



USA
 SERVICE OFFICE
 Dometic, LLC
 2320 Industrial Parkway
 Elkhart, IN 46516
 574-294-2511

CANADA
 Dometic, LLC
 46 Zatonski, Unit 3
 Brantford, ON N3T 5L8
 CANADA
 519-720-9578

For Service Center Assistance Call:
 800-544-4881

⚠ WARNING
 This manual must be read and understood before installation, adjustment, service, or maintenance is performed. This unit must be installed by a qualified service technician. Modification of this product can be extremely hazardous and could result in personal injury or property damage.

⚠ AVERTISSEMENT
 Lire et comprendre ce manuel avant de procéder à l'installation, à des réglages, de l'entretien ou des réparations. L'installation de cet appareil doit être effectuée par un réparateur qualifié. Toute modification de cet appareil peut être extrêmement dangereuse et entraîner des blessures ou dommages matériels.

INSTALLATION & OPERATION INSTRUCTIONS

Model
 747XXX07.000
 747XXX09.000
 747XXX11.000
 747XXX13.000

Form No. 3312822.004 10/08
 (French 3312828.000)
 ©2008 Dometic, LLC
 LaGrange, IN 46761 U.S.A.

Important: These Instructions must stay with unit. Owner read carefully.

SAFETY INSTRUCTIONS

This manual has safety information and instructions to help users eliminate or reduce the risk of accidents and injuries.

RECOGNIZE SAFETY INFORMATION



This is the safety-alert symbol. When you see this symbol in this manual, be alert to the potential for personal injury.

Follow recommended precautions and safe operating instructions.

UNDERSTAND SIGNAL WORDS

A signal word, **WARNING** OR **CAUTION** is used with the safety-alert symbol. They give the level of risk for potential injury.

WARNING indicates a potentially hazardous situation which, if not avoided, could result in death or serious injury.

CAUTION indicates a potentially hazardous situation which, if not avoided, may result in minor or moderate injury.

CAUTION used without the safety alert symbol indicates, a potentially hazardous situation which, if not avoided, may result in property damage.

Read and follow all safety information and instructions.

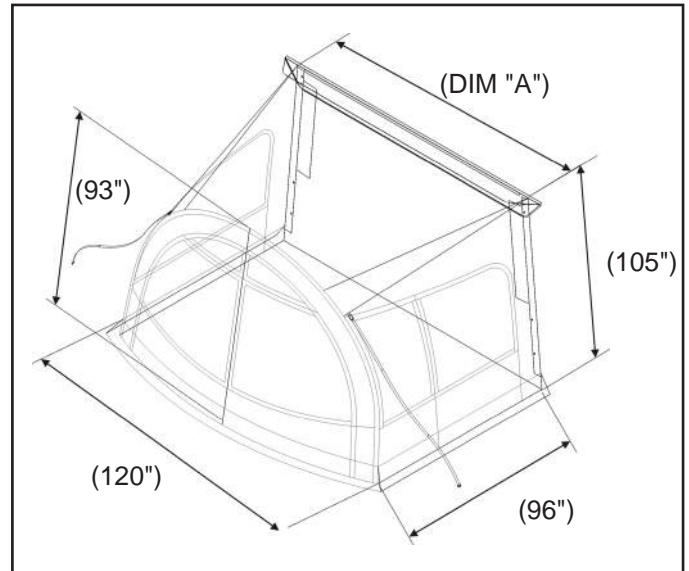

Model	Awning Size	Dim A (Width)	Approx. Cubic FT
747gRN07.000	7'	81"	625
747gRN09.000	9'	105"	710
747gRN11.000	11'	129"	796
747gRN13.000	13'	153"	881

general Information

APPLICATION:

The Cabana Lightweight RV Dome Awning™ is designed to fit most pop-up campers, allowing users to nearly double their current living space. In order to find the best size Dome Awning to use with your particular pop-up camper, measure the size of the awning rail on your camper. Choose one of the four Cabana Lightweight RV Dome Awning™ sizes to match the length of your awning rail: 7', 9', 11' or 13'. If your awning rail does not match any of these 4 sizes exactly, choose the next shortest size available. For example, if your awning rail is 12', an 11' Dome Awning would provide the best fit on your camper. Product features and specifications as described or illustrated are subject to change without notice. Installation methods not described in this manual must have written approval from Dometic, LLC.

Important: Read the entire Installation and Operating Instructions carefully before starting the installation.

CONTENTS:

- Bag Awning/Room
- (1) Flex Pole (collapsible)
- (16) Snap Fast Fasteners
- (3) Roof Poles (adjustable)
- (25) Tent Stakes
- (2) Hold Down Webbing Straps
- Mesh Vehicle Skirt
- Mesh Wheel Well Skirt



3. Unzip bag & undo ties to roll fabric assembly out.
Unrolled fabric assembly



B. Assemble Poles and Dome Awning: Flex Collapsible Pole (1) & Telescoping Aluminum Poles (3)

1. Assemble collapsible flex pole. Prepare Dome Awning for flex pole by unzipping front panel from the bottom up. Stop approximately at the buckles. Insert flex pole into sewn-in pocket located on front of Dome Awning. Push flex pole through entire front pocket.

Note: Do not try to pull flex pole through. Pulling will only disassemble sections of the flex pole.

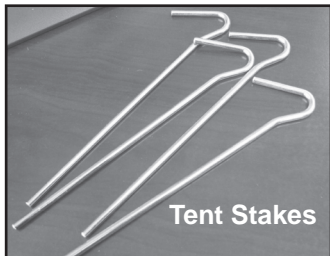
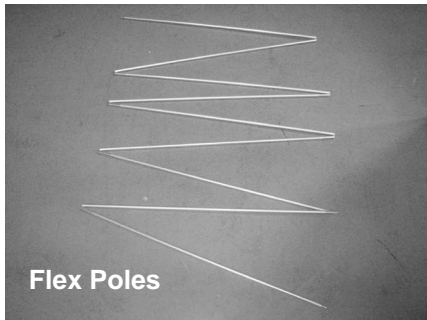

TOOLS REQUIRED:

- Power Drill/Screwdriver
- Silicone spray/Lubricant

A. Slide Bag Into Standard Awning Rail

1. Spray inside of awning rail with silicone spray or lubricant to ease sliding bag through awning rail. Make sure Dometic logo faces away from camper.
2. If the awning is to be left mounted during travel, secure each end by installing a #6 X 1/2" (included) drill point screw in each end.

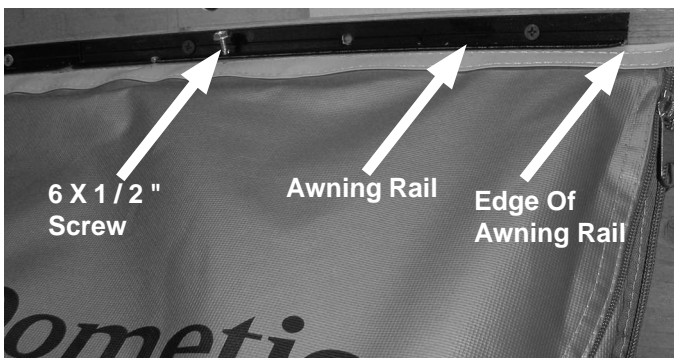

When flex pole is pushed through entire front pocket, secure 1 pole end into brass grommet in webbing.

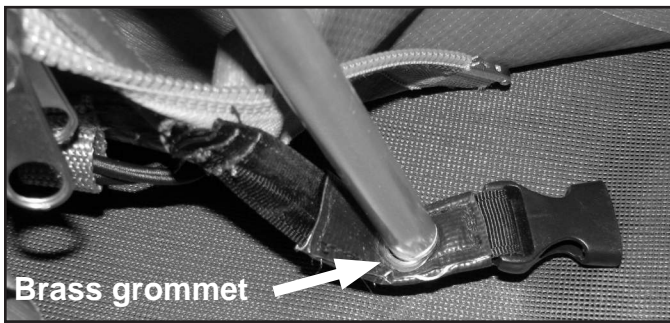
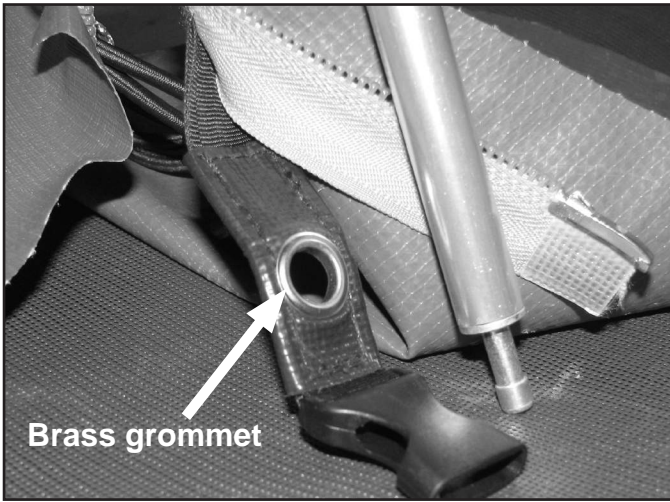

Buckle webbing strap on opposite side.



2. Form arch with flex pole & insert other end of flex pole into brass grommet on webbing. Erect arch and with someone's help, hold in place while telescoping aluminum roof poles are installed inside Dome Awning.



3. Open lock on Clenchlock Lever System of telescoping aluminum roof poles.



4. Insert ball end into ball end socket built into rear flap of bag assembly against camper wall as shown.



5. Hook opposite end of telescoping pole onto front flex pole thru opening in fabric assembly. This operation is easier to do from outside of Dome Awning or with help from outside of Dome Awning.



6. Extend telescoping pole to stretch roof fabric out and lock Clenchlock Lever in place.

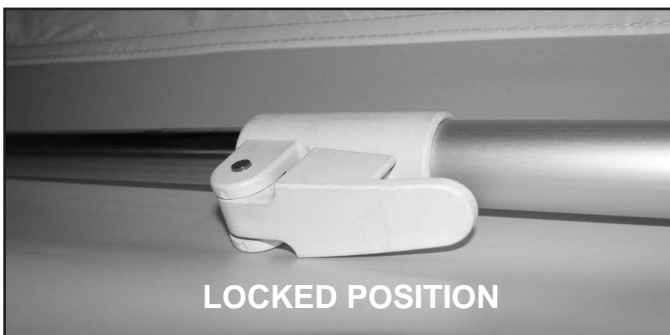

Repeat above step with remaining 2 telescoping poles.

C. Seal Dome Awning & Install Skirts

1. Straighten out fabric and fold bottom flaps towards outside.



2. Once Dome Awning is in place, install snap fast fasteners where side wall flaps meet camper. This provides a seal between tent room and camper.

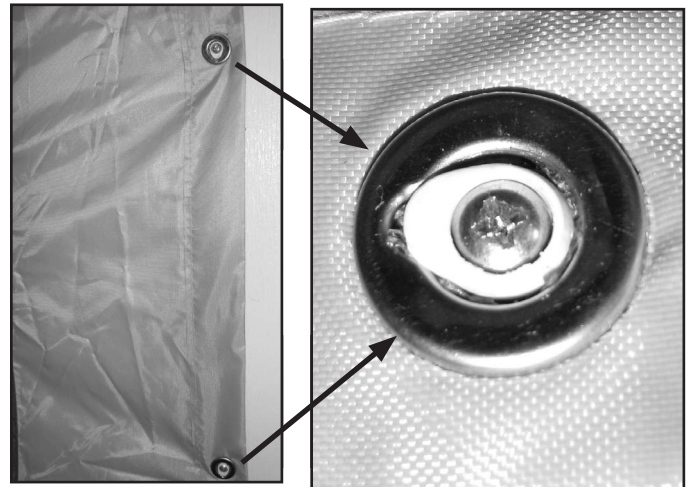

3. Roll flaps w/Velcro around camper extender arms.
4. Install Wheel Well Skirt over wheel well by marking grommet points at desired height and drilling pilot holes then installing snap fast fasteners.
5. Mark grommet points and drill pilot holes to install snap fast fasteners for Vehicle Skirt. Measure and install Vehicle Skirt across entire vehicle. Cut excess skirt if necessary.

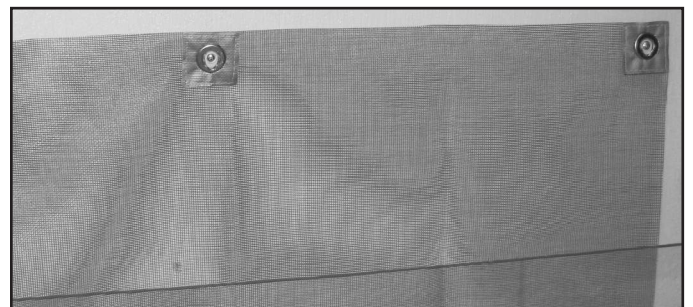

D. Operating Tips

1. Side door can be rolled up & tied for convenient entry & exit or it can be zipped shut for privacy and help prevent flying insects from entering.
2. Privacy panels on Dome Awning can be rolled up & tied in place with sewn-in ties to allow for air circulation and visibility.
3. Dome Awning can also be used as breezeway by unzipping & rolling up both sides.

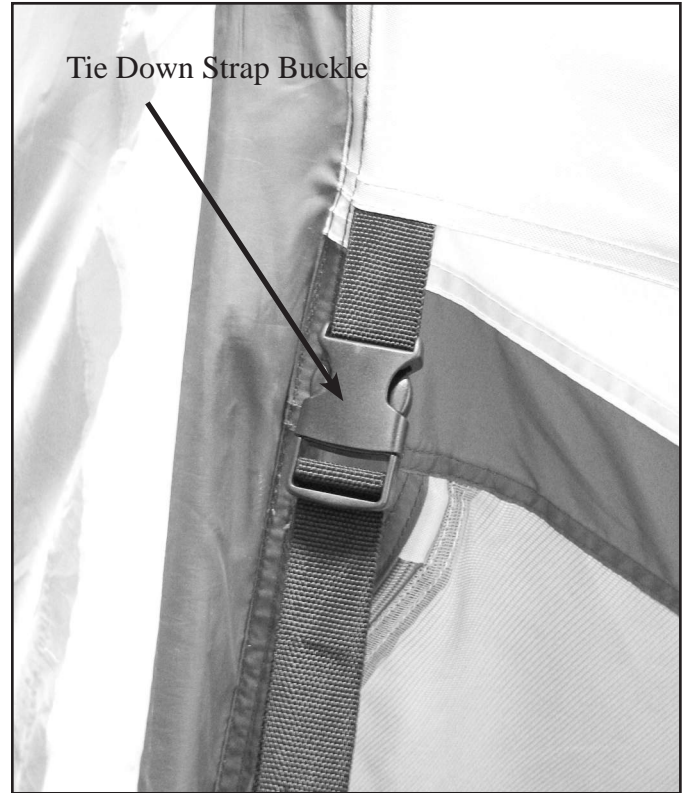

Elastic cord loops at the hem of Dome Awning provide extra stability when staked to ground with included tent stakes.

4. To use Dome Awning as a porch, unzip & roll up both sides and remove entire front panel.

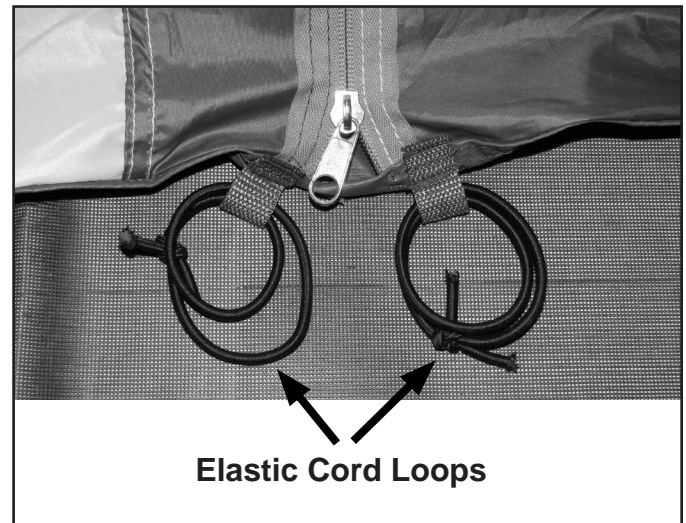

To remove front panel, unzip panels from the top center down.

5. Optional hold down straps are included with the Cabana Lightweight RV Dome Awning™ in case additional stability is required in windy conditions. Buckle one end to mating buckle attached to top of side panel on Dome Awning. Secure opposite end of strap to ground with tent stake.

E. Cabana Lightweight RV Dome Awning™ Storage

Note: If Dome Awning is put away when conditions are wet, it should be set up and allowed to dry dry as soon as possible to prevent mold and mildew.

1. Remove tent stakes, if any were installed, from hem and from hold down straps.
2. Unroll privacy panels and door and zip front panel, if it was previously removed. Leave front panel unzipped from bottom to buckle location.

3. Remove Vehicle Skirt and Wheel Well Skirt from camper. Skirts can be folded and stored in the Dome Awning bag. Fasteners may be left on the camper for next time you use your Dome Awning.
4. Lower camper extender arms, if possible, as low as possible to allow for better reach to Dome Awning poles and bag or use a step stool.
5. Remove telescoping poles one at a time by unlocking Clenchlock lever then unhooking from front flex pole then pulling opposite end of pole from ball end base on bag. Set poles aside as they will be stored in the bag with the rest of the Dome Awning and Skirts.
6. Remove flex pole from pocket on Dome Awning front by first unbuckling webbing strap on bottom front.
Pull end of flex pole out of brass grommet on webbing strap, one side at a time. Now you are ready to push flex pole through pocket. **DO NOT TRY TO PULL FLEX POLE THROUGH POCKET.** Collapse flex pole and set aside with telescoping poles for storage in Dome Awning bag.
7. Now that you have the Dome Awning fabric assembly hanging without poles, fold in side panels of fabric towards the center of the fabric assembly so as to try to make a square. "Square" fabric assembly should not extend beyond the width of the bag itself.

8. Place all poles at the end of the fabric assembly farthest away from the camper and begin rolling up towards camper as tightly and neatly as possible. This process is best done with two persons.



9. Once the entire Dome Awning assembly is rolled up, fasten with ties sewn inside bag (3).
10. Zip Dome Awning bag closed. Insert Skirts and bagged tent stakes into bag as well.



⚠ WARNING

TO REDUCE THE RISK OF DEATH, PERSONAL INJURY, FIRE OR DAMAGE:

1. Do not use grills, hibachis, camp stove or gas burning lamps inside the Cabana Lightweight RV Dome Awning™.
2. Never operate generators, motorcycles, any internal combustion engines inside the Cabana Lightweight RV Dome Awning™.
3. Close attention is necessary when used by or near children. Do not allow children or adults to lean against the sides or front of the Cabana Lightweight RV Dome Awning™.
4. Do not suspend electrical lights from rafter poles or allow them to come in contact with the fabric Cabana Lightweight RV Dome Awning™.
5. Do not modify or change the installation of this Cabana Lightweight RV Dome Awning™.
6. Use only as described in this manual.



LIMITED ONE (1) yEAR WARRANTY

THE SELLER NAMED BELOW MAKES THE FOLLOWING WARRANTY WITH RESPECT TO THE DOMETIC PRODUCT:

1. This Warranty is made only to the first purchaser (hereinafter referred to as the "Original Purchaser") who acquires the product for his own use and is installed and operated within the continental United States and Canada.
2. This Warranty will be in effect for one (1) year from the date of purchase by the original purchaser. It is suggested that the original purchaser retain a copy of the dated bill of sale as evidence of the date of purchase.
3. This Warranty covers only specified parts which shall be free from defects in material and workmanship under normal use. This warranty does NOT cover conditions unrelated to the material and workmanship of the product. Such unrelated conditions include, but are not limited to: (a) damage not reported within seven (7) days of ownership; (b) failure or damage caused by storms, rain, water pooling, or any acts of God; (c) faulty installation and any damage resulting from such; (d) the need for normal maintenance and any damage resulting from the failure to provide such maintenance; (e) failure to follow Sellers instructions for use of this product; (f) any accident to or misuse of any part of this product and any alteration by anyone other than the Seller or its authorized representative; (g) damage or failure caused by installation of accessories not manufactured and marketed by the Seller; and (h) normal wear and product abuse.
4. The specified parts covered by this warranty, where applicable, are as follows: (a) Roller tube against rust, corrosion and extrusion defects; (b) Fabric free from quality defects (normal wear is not covered); (c) Screen assemblies free from quality defects (normal wear is not covered); (d) Torsion assemblies, including motor-driven assemblies, against extrusion defects, electrical faults, or breakage; and (d) Hardware against extrusion defects.
5. In order to obtain the benefits of this warranty, you should return the product which you find defective to the Seller named below or to a Dometic Authorized Service Center during the period that this warranty is in effect. The original owner is responsible for all charges incurred in delivery of the product to the Seller, or Dometic Authorized Service Center, and in pick up after the warranty service has been completed. To obtain the location of the nearest Authorized Service Center, please call 1-800-544-4881. In Canada, call 1-519-720-9578.
6. Any item returned in the manner described in paragraph 5 will be examined by the Seller or the Authorized Dometic Service Center. If it is found that the returned item was defective in material and workmanship, the Seller or the Authorized Dometic Service Center will repair the product per the terms of this one (1) year limited warranty without charge for material or labor during the first year of ownership by the original purchaser. CONFIRM THE SERVICE AGENCY IS AN AUTHORIZED DOMETIC SERVICE CENTER. DO NOT PAY THE SERVICE AGENCY FOR WARRANTY REPAIRS. SUCH PAYMENTS WILL NOT BE REIMBURSED.
7. Dometic, LLC will pay freight on replacement parts during the first ninety (90) days of ownership by the original purchaser.
8. The Seller does not authorize any person or company to create any warranty obligations or liability on their behalf. This warranty is not extended by the length of time which you are deprived of the use of the product. Repairs and replacement parts provided under the terms of this warranty shall carry only the non-expired portion of this warranty.
9. In no event shall either Seller be liable for incidental or consequential damages. This includes any damage to another product or products resulting from such a defect. Some states do not allow the exclusion or limitation of incidental or consequential damages, so the above limitations may not apply.
10. Any implied warranty, including the implied warranty of merchantability and fitness for any purpose, is limited to the duration of this limited warranty. Some states do not allow limitations on how long an implied warranty can last, so the above limitation may not apply.
11. THIS WARRANTY GIVES YOU SPECIFIC LEGAL RIGHTS, YOU MAY ALSO HAVE OTHER RIGHTS WHICH VARY FROM STATE TO STATE. No action to enforce this warranty shall be commenced later than ninety (90) days after the expiration of the warranty period. Claims must be submitted in writing to the Dometic Warranty Department for arbitration.
12. All products (except those specifically built for commercial use) are warranted only when installed on vehicles built to R.V.I.A. and C.R.V.A., Z-240 Standards.
13. The Seller reserves the right to change the design of any product without notice and with no obligation to make corresponding changes in products previously manufactured.

DOMETIC, LLC
Warranty Department
2320 Industrial Parkway
Elkhart, Indiana 46515
Phone: 574-294-2511
Fax: 574-294-4637