

## WF-8700 Series

WF-8712P | WF-8725P | WF-8735P | WF-8740P

(The Power Center model number is located on the front panel label near the AC breakers)



## THE HEARTBEAT OF TODAY'S RVs

Distributed in the U.S.A. and Canada by  
ARTERRA DISTRIBUTION

(877) 294-8997

Warranty: [warranty@wfcoelectronics.com](mailto:warranty@wfcoelectronics.com)

Fax (574) 294-8698

[www.wfcoelectronics.com](http://www.wfcoelectronics.com)



Power PROs Technical Support  
(877) 294-8997

## TABLE OF CONTENTS

SAFETY INFORMATION .....	3
GENERAL INFORMATION	
Reverse Battery Protection .....	3
Blown Fuse Indicators .....	4
Automatic Cooling Fan .....	4
Over-Temperature Protection .....	4
Electronic Current Limiting .....	4
Short Circuit Protection .....	5
CIRCUIT PROTECTION	
DC Fuses .....	5
AC Circuit Breaker .....	5
UL-Listed Main Circuit Breaker List .....	5
UL-Listed Branch Circuit Breaker List .....	5
OPERATIONAL FEATURES	
Three Stage Smart Charging .....	7
TROUBLESHOOTING INSTRUCTIONS	
Converter Output Voltage .....	8
Reverse Polarity Fuses .....	8
Troubleshooting Flow Chart .....	9
GENERAL COMPLIANCE INFORMATION	
Agency Listings .....	9
INSTALLATION INSTRUCTIONS	
Mounting the Enclosure .....	10
Wiring the AC Breakers .....	10
Wiring the DC Fuse Board .....	11
SPECIFICATIONS .....	12
WARRANTY INFORMATION .....	13





<b>⚠ WARNING</b>
<b>RISK OF ELECTRICAL SHOCK</b> Disconnect or isolate all power supplies before making electrical connections. More than one disconnection or isolation may be required to completely de-energize equipment. Contact with components carrying hazardous voltage can cause electric shock and may result in severe personal injury or death.
<b>NOTICE</b>
All wiring must conform to local, national, and regional codes and regulations. Use copper conductors only for all wire connections. Do not exceed the electrical ratings for the WF-8700 Series Converter/Charger or the equipment connected to it. Failure to follow these precautions may cause equipment failure and/or electrical shock which could result in severe personal injury or death.
<b>⚠ CAUTION</b>
<b>INSTALLATION AND SERVICING</b> This product should be installed and serviced by a certified or licensed electrician familiar with applicable safety codes and installation requirements. Failure to observe this precaution could result in electrical shock or bodily injury. Consult your servicing dealer before attempting any work on this product.
<b>⚠ WARNING</b>
<b>SPARK HAZZARD</b> This unit employs components that can produce arcs or sparks. To prevent fire or explosion, do not install in compartments containing batteries or flammable materials (LP gas). This product is NOT ignition protected.
<b>⚠ CAUTION</b>
<b>DO NOT OBSTRUCT VENTILATION OPENINGS</b> To prevent fire, DO NOT cover or obstruct enclosure ventilation openings. DO NOT mount the WF-8712P or WF-8725P in a zero-clearance compartment as overheating may result. These units requires a 2 cubic foot (min) vented area behind the unit for cool air exchange.
<b>⚠ WARNING</b>
<b>BATTERY SYSTEM</b> Use converter only on appropriate battery systems. Other usage may cause personal injury and damage. Consult all battery manufacturer's recommendations for additional safety information before use.

## GENERAL INFORMATION

### WF-8700 Series Power Center Safety Features

#### Reverse Battery Protection

The WF-8700 Series Power Centers will charge the 12-volt House battery if installed. A battery DOES NOT have to be installed for WF-8700 Series Power Center converter operation. When a battery is installed, a reverse polarity fuse protects the converter circuitry. The fuse is located along the bottom of the row of fuses. Refer to Figure 1 below. This feature prevents permanent damage to the converter from a battery connected into the circuit backwards. In addition to protecting the converter section, the reverse polarity fuse is the main connection between the converter and the DC fuse board.



The fuse values and quantity vary depending on which WF-8700 Series Power Center you have. Refer to the table and drawing below.

- WF-8712 – 15A (1)
- WF-8725 – 30A (1)
- WF-8735 – 40A (1)
- WF-8740 – 30A (2)

### Blown Fuse Indicators on DC Fuse Board

The DC Fuse Board has individual blown fuse indicators as standard equipment. The WF-8712P & WF-8725P have 4 DC circuits (3 Branch and 1 Battery). The WF-8735P and WF-8740P have 6 DC circuits (5 Branch and 1 Battery). Each of the circuits contain a Red LED to indicate a blown fuse. If one of the circuits draws more current than the rating of the fuse, the fuse will blow. When this occurs, the Red LED for that circuit will illuminate. **NOTE:** The fuse board employs surface mount LEDs which are barely visible to the naked eye. Replace the blown fuse with a known good fuse of the same rating. **NOTE:** If the replacement fuse blows again, check that circuit for a short or overload condition.

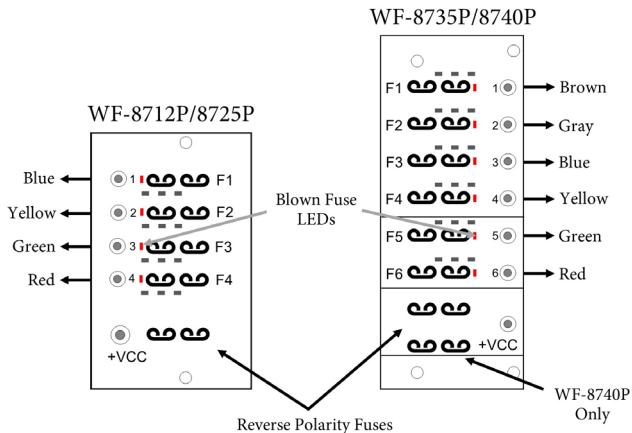

Figure 1

### Automatic Cooling Fan

The cooling fan in the WF-8700 Series Power Center is incremental and is controlled by the current drawn out of the converter to the applied load. **NOTE:** The WF-8712P does not have a fan. The on-board microprocessor increases fan speed as the total load increases and decreases fan speed as the load decreases. Unlike traditional temperature-controlled fans, the load-controlled fan provides better component cooling by avoiding temperature spikes which can lead to premature component failure.

### Over-Temperature Protection

If the internal temperature of the converter exceeds a critical point, it will shut down. This protects the unit from excessive heat that may damage sensitive components. The unit will restart once the temperature inside has dropped.

### Electronic Current Limiting

In the event that the output current exceeds the maximum rating for the WF-8700 Series Power Center converter, the output current will remain constant, but the output voltage will begin to drop. If this occurs, the unit will recover once loads are reduced.



## Short-Circuit Protection

Should a short-circuit occur in the RV, the WF-8700 Series Power Center converter will drop the voltage output to zero volts. If the short-circuit condition is removed and no other fault conditions are detected, the converter will resume normal operation. However, short-circuit conditions are dangerous, and an RV will require inspection by a qualified service technician.

## CIRCUIT PROTECTION

### WF-8700 Series Power Center Fuses and Breakers

#### DC Fuses (12 Volts)

The DC fuse boards have spaces the Branch, Battery and Reverse Polarity fuses as described above. Should any of fuses blow, the Branch Circuit fuses and the Reverse Battery Protection fuses should be replaced with ATC or ATO automotive type fuses such as:

- Littelfuse type 257
- Bussmann type ATC

#### AC Circuit Breakers (120/240 Volts)

The AC Breaker side of the WF-8700 Series Power Center is located on the left side of the enclosure. The WF-8700 Series Power Center accepts standard residential breakers. The WF-8712P and WF-8725P have spaces for a 30 Amp Main and up to 3 Branch breakers when using duplex breakers. The WF-8735P and WF-8740P have spaces for a 30 Amp Main and up to 5 Branch breakers when using duplex breakers. A list of factory tested and approved breakers follows. The breakers may be purchased at most big-box department stores and home centers.

#### UL-Listed Main Circuit Breakers, Rated for 120V, Maximum 30A

The following breakers have been factory tested and approved for use as 30 Amp Main breakers in the WF-8700 Series Power Center:

<b>Manufacturer</b>	<b>Model/Cat. No./Type</b>
Cutler Hammer	Type BR and C
Thomas Betts	Type TB or TBBD
ITE/Siemens	Type QP or QT
Square D	Type HOM or HOMT
Murray	Type MP-T or MH-T
General Electric	Type THQL

#### UL-Listed Branch Circuit Breakers, Rated for 120V, Maximum 20A

The following breakers have been factory tested and approved for use as Branch breakers in the WF-8700 Series Power Center:



Manufacturer	Model/Cat. No./Type
Cutler Hammer	Type BR and C, Type BRD, BD and A
Thomas Betts	Type TB or TBBD
ITE/Siemens	Type QP or QT
Square D	Type HOM or HOMT
Murray	Type MP-T or MH-T
General Electric	Type THQL

When replacing any of the installed circuit breakers, the replacement should be of the same manufacturer, type designation, and equal interrupting rating, not to exceed 30A. The "Short-Circuit-Current" rating for the breaker should be 10,000 Amps.  
 Breaker Filler Plates: Model #FP-01 or FP-01B (Black)

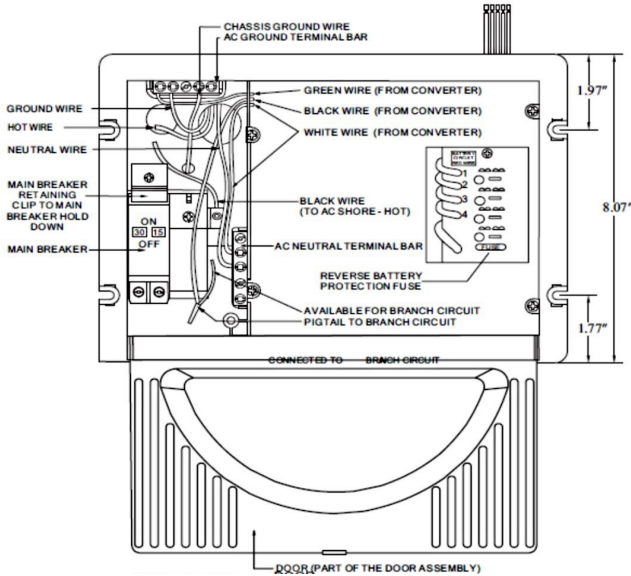

### WF-8735 and WF-8740 Wiring Diagram

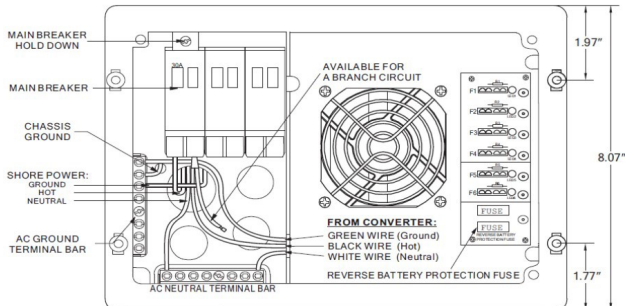

Figure 2

# OPERATIONAL FEATURES

## Converter Operation Modes



### Three-Stage Smart Charging

In order to maximize battery life, it is best to charge batteries slowly, keep them topped off with a trickle-charge when the RV is not being used. The 3-Stage “smart” charger continuously measures the battery voltage output and regulates the amount of charge using three modes of operation; Absorption, Bulk and Float modes.

All WFCO power converters are automatic three-stage switching power supplies. The converter senses which mode it needs to be in by checking the RV system voltage.

The converter normally provides a constant target output voltage of 13.6 VDC (nominal) to power all the branch circuits. However, it is current limited, and if the output (load) current reaches its maximum, the output voltage will drop as necessary to hold the converter’s maximum output current level (the Amperage rating) without exceeding it.

If the output current reaches its maximum (normally caused by a discharged battery), this will cause the converter to go into Bulk Mode, which means the target output voltage will change to 14.4 VDC and a timer will start. Although the converter is outputting 14.4 VDC, you will not be able to read that on a voltmeter due to the voltage-current relationship. From the paragraph above, as load current increases, output voltage decreases. The actual output voltage will not rise until the load current is reduced, which happens naturally as the battery charges or if 12 VDC appliances are turned off.

Bulk Mode will be maintained until the current draw drops to approximately five Amps, or until the timer reaches four hours (whichever happens first). Then the target output voltage is changed back to 13.6 VDC for Absorption Mode. Lights that are powered from the output may change brightness slightly at that time

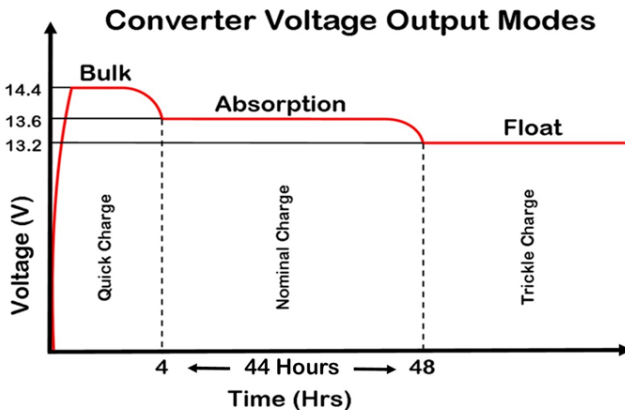

Figure 3

**Note:** For a detailed explanation of the charging modes, please refer to our publication “Theory of Operation”, document #AD-TD-0001-0.



## Troubleshooting the WF-8700 Series Power Center

Refer to the Troubleshooting Guide for the WF-8700 Series Power Center (Figure 4) below.

### Check Converter Output Voltage

Before checking the WF-8700 Series Power Center output voltage, disconnect the battery cables at the battery. Make sure the converter is plugged into an AC source (105-130 VAC). Check the converter output voltage at the battery with a voltmeter. Place the meter probes on the disconnected battery cables; place the **Positive** (red) meter probe on the + **Positive** red battery wire and place the **Negative** (black) meter probe on the - **Negative** black wire on the battery cable. Be sure you have good connections at the cables. If the voltage reads 13.6 VDC (+/- 0.2) with no load, the converter is functioning properly.

If the converter output voltage at the battery reads 0.0 VDC, or if the battery is not charging, check for an open inline fuse in the battery wire circuit. One may have been installed by the RV manufacturer. Also check for loose wiring connections.

**NOTE:** The battery circuit (Red wire) should have the following fuse installed:

WF-8712P – Circuit #4 – 15 A

WF-8725P – Circuit #4 – 30 A

WF-8735P – Circuit #6 – 30 A

WF-8740P – Circuit #6 – 30 A

### DC Reverse Polarity (Fuses)

If there is no DC output coming from the WF-8700 Series Power Center converter section, first check the reverse polarity fuse(s) on the fuse board. Then, visually inspect the fuses for any breaks in the fuse element. If no breaks are found, use a continuity tester to check for continuity. If the reverse polarity fuses are blown, it means the RV battery was accidentally connected in reverse, either at the battery or at the converter. Investigate the connections and reconnect the cables properly. Replace the fuse with the same type and Amperage rating as the original.

**IMPORTANT:** These fuses protect the converter from damage in the event that the RV battery is accidentally connected in reverse. A reversed battery connection, even if for only a second, will cause these fuses to blow.

If the above checks have been made but the converter output still reads 0.0 VDC, the converter is not functioning properly. Contact the Arterra Distribution Power PROs at 1 (877) 294-8997. Before placing the call, please have available the WF-8700 Series Power Center model number from the front panel label and the 14-digit serial number from the bar code tag located on the fan panel. The fan panel is accessible after the door assembly has been removed.

### AC Reverse Polarity (Audible Alarm)

This power center is equipped with an AC REVERSE POLARITY PROTECTION feature. Should the incoming AC neutral wire and lead wire be connected backwards at the power center, an alarm located in the power center enclosure will sound. This alarm will continue to sound until the AC wires are connected correctly.



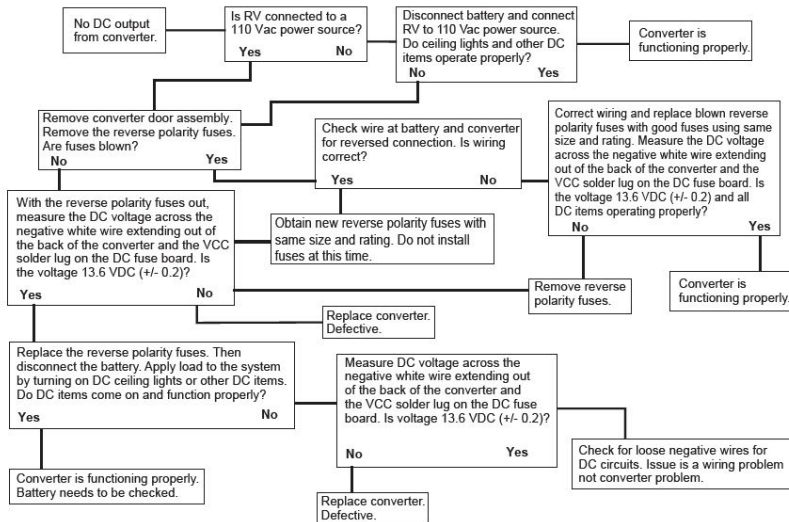

Figure 4

Should it be determined that the converter section of the WF-8700 Series Power Center is defective, and the unit is under warranty, the entire unit will need to be returned. The converter section is not user serviceable.

When preparing the unit for return, remove the AC breakers. Label and disconnect each wire as they are removed from the breakers and Ground and Neutral bars. The DC wires protruding from the back of the WF-8700 Series Power Center have been connected to the DC circuits in your RV by the RV manufacturer. In a similar fashion, label and disconnect these wires. Follow the packaging instructions in your warranty claim packet.

## GENERAL COMPLIANCE INFORMATION

### Agency Listings

#### UL

The WF-8700 Series Power Centers are UL-Listed, and cUL-Listed (Canadian).

#### FCC Compliance Class B

NOTE: This equipment has been tested and found to comply with the limits for a Class B digital device, pursuant to Part 15 of the FCC Rules. These limits are designed to provide reasonable protection against harmful interference when the equipment is operated in a commercial environment. This equipment generates, uses, and can radiate radio frequency energy, and if not installed and used in accordance with the instruction manual, may cause harmful interference to radio communications. Operation of this equipment in a residential area is likely to cause harmful interference in which case the user will be required to correct the interference at his own expense.



# INSTALLATION INSTRUCTIONS

## Installing the WF-8700 Series Power Center

### Mounting the Enclosure

The WF-8700 Series enclosure should be mounted in an accessible area such as a wall or in the side of a cabinet. The front of the enclosure should not be obstructed to allow free air flow for the cooling fan. NOTE: The WF-8712P does not have a fan. The enclosures will slide into rough openings as follows:

- WF-8712P and WF-8725P – 10 7/16" W x 6 1/8" H x 3 3/4" D
- WF-8735P and WF-8740P – 10 3/8" W x 6 7/8" H x 4 5/16" D

After wiring is completed, the enclosure fastens to the wall or cabinet using 4 wood screws (not supplied).

#### WARNING

##### **RISK OF ELECTRICAL SHOCK**

Disconnect or isolate all power supplies before making electrical connections. More than one disconnection or isolation may be required to completely de-energize equipment. Contact with components carrying hazardous voltage can cause electric shock and may result in severe personal injury or death.

### Wiring the AC Breakers

**Make sure no AC power is coming into the RV from either the Shore Power cord or an on-board generator.** Determine the proper size breakers for the loads the WF-8700 Series Power Center will be powering. You can use either single or duplex breakers, or a combination of both. We recommend that all the breakers used be of the same brand. A total of 4 breakers can be mounted in the WF-8712P and WF-8725P when using duplex breakers: 1 Main breaker and up to 3 Branch breakers. A total of 6 breakers can be mounted in the WF-8735P and 8740P when using duplex breakers: 1 Main and up to 5 Branch breakers. Refer to the tables on pages 5 and 6 for a selection of approved breakers. The Main breaker should be 30 Amp and is to be installed in the left-most position. See the wiring diagrams below. A hold down clip is provided to keep the breaker securely in place.

The 30 Amp power cord is routed through the large knockout in the back of the wiring compartment and secured with a Romex clamp. The Black (Hot) wire is connected to the 30 Amp Main breaker as shown. The White (Neutral) wire is connected to the Neutral Terminal bar at the bottom of the wiring compartment. The Green (Ground) wire is connected to the Ground Terminal bar also located at the bottom of the compartment.

Route the Romex leads for the Branch circuits through the Strain Reliefs in the back of the wiring compartment. In a similar fashion, connect the Black wire to the Branch breaker and the White and Green wires to the appropriate Terminal bar.

The Black power wire for converter power on the WF-8735P and WF-8740P has a pigtail connection. The metal pin is inserted in the Branch breaker designated for converter power. The end with the wire nut can be used to power another circuit if necessary. If not used, leave the wire nut installed and push the wire to the side. Make sure all terminals are torqued to the specifications listed on the back of the door assembly.

## Wiring the DC Fuse Board

Make sure the house battery is disconnected before beginning the DC wiring. Determine what DC loads are to be connected to the fuse board and what position they will occupy. All 4 circuits on the WF-8712 and WF-8725 Power Centers have up to 20 Amp ATO or ATC fuses installed. On the WF-8735 and WF-8740 Power Centers, circuits F5 and F6 can be used for slide-outs or other higher current loads and can have a maximum 30 Amp ATO or ATC fuse installed. The remaining 4 circuits are general purpose and can have up to 20 Amp ATO or ATC fuses installed. Make sure the fuses are seated properly.

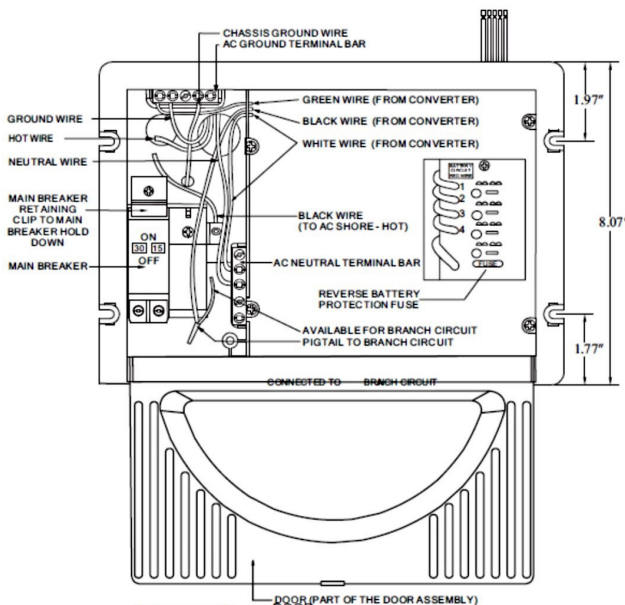

## WF-8735 and WF-8740 Wiring Diagram

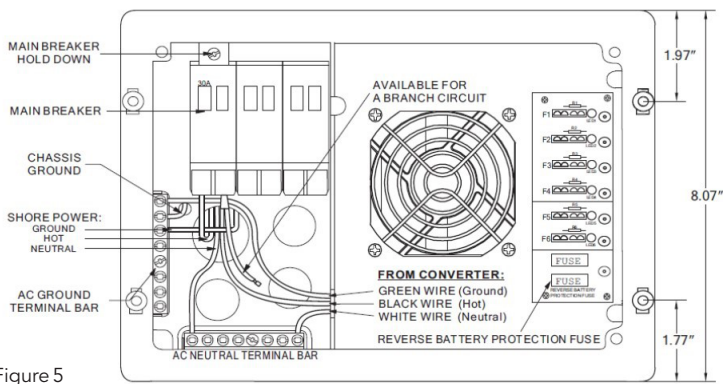

Figure 5



All models have wire lead connections. Strip approximately 1/4" of insulation from the wires and attach to the appropriate connected load using a wire nut or other approved method. Make sure the connectors are tightly secured.

Connect the heavy wire (Red) coming from the battery to the Red 10AWG wire coming from the back of the enclosure.

As a last step, install a separate bus bar in a location behind the converter. Connect the 10AWG White wire coming from the back of the enclosure to this bus bar. Connect the battery negative wire to this bus bar along with all the negative DC load wires. Also, run a wire from the bus bar to chassis ground.

WF-8700 Power Center Specification				
Model No.	WF-8712	WF-8725	WF-8735	WF-8740
<b>Converter Input Power:</b>				
Voltage:	105-130VAC			
Frequency:	60Hz			
Max. input current @105Vac	2.5A	5A	7A	8A
Max Power	205 Watt	425 Watt	595 Watt	680 Watt
<b>Converter Output Power</b>				
Continuous power:	163 Watt	340 Watt	475 Watt	545 Watt
Rated DC Output Voltage	13.6V			
Rated DC Current	12A	25A	35A	40A
Charging Control	Automatically controlled by microprocessor			
Charging Modes	3-stage Intelligent charge			
Intelligent charge mode	Absorption · Bulk · Float (Storage)			
Battery Adaptability	LA/AGM			
Absorption charge voltage	13.6V			
Bulk charge voltage: (4 Hrs)	14.4V			
Storage charge voltage	13.2V			
Regulation	± 1% accuracy against input or load changes			
Cooling Fan	Incremental two speed according to the DC load Amperage			
VA Efficiency:	> 80% (under 70% of load condition)			
<b>Protection:</b>				
Overload	Current-limiting & shut down; auto recovery upon normal load			
Short-circuit	Shut down & auto recovery upon return to normal load			
Over-temperature	Shut down & auto recovery upon return to normal load			
Battery reverse polarity	Protected by Fuse; same rated fuse replacement required			
<b>AC Distribution</b>				
Mains Rating	Max. 30A / 120VAC			
Breakers	1 x 30A Main and 3 branch using duplex breakers		1 x 30A Main and 5 branch using duplex breakers	
Romex strain reliefs	none			
<b>DC Distribution Board</b>				
Standard DC Output loops	4 x 20 Amp max. each		2 x 30 Amp ; 4 x 20 Amp max. each	
LED on Fuse Board:	Total 4 chip-LEDs; Red indicating fuse blown status of loops		Total 6 chip-LEDs; Red indicating fuse blown status of loops	
Visual Window:	Transparent window on WF-8735P & 8740P for reading LED status easily			
<b>Mechanical:</b>				
Zero Clearance:	None - requires 2 cu ft (min) vented area behind unit for cool air exchange		Special design air cooling duct to avoid heat dissipating into confined space	
Dimension: W x H x D	11.85 x 7.25 x 5.12 inch / 300 x 184 x 130 mm		11.85 x 8.27 x 5.24 inch / 300 x 210 x 133 mm	
Cutout Size: W x H	10.43 x 6.1 inch / 265 x 155 mm		10.43 x 6.89 inch / 265 x 175 mm	
Weight:	2.06 kg	2.15 kg	2.35 kg	
Environmental Condition:	20 ~ 90% Non-condensing			
Safety	UL458 /UL67 certified; FCC Class B compliant			

Figure 6



## CONSUMER LIMITED WARRANTY for WFCO Electronic Products

WFCO extends, to the original owner, a Two Year Limited Product Warranty. This warranty is in effect from the date of original purchase for a period of two (2) years. This limited warranty is extended specifically for and is limited to Recreational Vehicle application and is only valid within the continental United States, Alaska, Hawaii and the Provinces of Canada. WFCO warrants, to the owner, that its products are free from defects in material and workmanship under normal use and service based on its intended use and function. This warranty is limited to the repair or replacement, at WFCO's discretion, of any defective parts or defective assembly. Any implied warranties of merchantability or fitness for intended use are limited in duration unless applicable State Law provides otherwise. You may have other rights as specified by each individual state.

### EXCLUSIONS and LIMITATIONS

The OEM warranty specifically does not apply to the following:

- Any WFCO product that has been repaired or altered by an unauthorized person;
- Any damage caused by misuse, faulty installation, testing, negligence, accident or any WFCO product installed in a commercial vehicle;
- Any WFCO product, whose serial number has been defaced, altered or removed;
- Any WFCO product, whose installation has not been in accordance to the WFCO written instructions;
- Any consequential damages arising from the loss of use of the product including but not limited to: inconvenience, loss of service, loss of revenue, loss or damage to personal property, cost of all services performed in removing or replacing the WFCO product. Specifications are subject to change without notice or obligation.
- Any WFCO Electronics products sold through unauthorized Internet sources (Example: eBay) will be excluded from all warranty coverage offered by Arterra Distribution / WFCO.

### CONSUMER WARRANTY CLAIM PROCEDURE

Upon determination and validation by an authorized OEM dealer that a WFCO product has a defect, a Return Goods Authorization (RGA) number will be required before the product can be returned. The RGA number can be requested by completing the Warranty Information Fax Sheet and appropriate Troubleshooting Form found at [www.wfcoelectronics.com](http://www.wfcoelectronics.com). Once these forms have been completed, email the forms along with Proof of Purchase to [warranty@wfcoelectronics.com](mailto:warranty@wfcoelectronics.com) or fax the three documents to the Warranty Department at (574) 294-8698. After receipt of the forms, an RGA number will be issued. This number shall appear on all correspondence with warranty service. Upon validation of the warranty, WFCO shall replace the product with a like product. The RGA number shall be placed on the outside of the carton used to return the product for ease of identification. Do not mark directly on the product. The product must be packaged properly to avoid further product damage which could cause a non-warrantable condition.

### WARRANTY ASSISTANCE

The consumer may contact the selling Dealer or OEM for warranty assistance. The consumer may also contact Arterra Distribution, exclusive distributor to WFCO Products at: (574) 294-8997 or Fax (574) 294-8698.



# WF-8712/8725 Power Center

## Top View

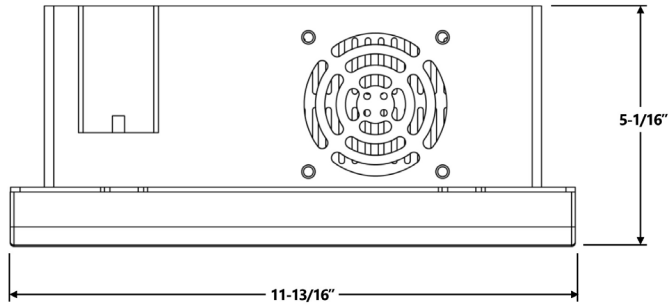

## Back View

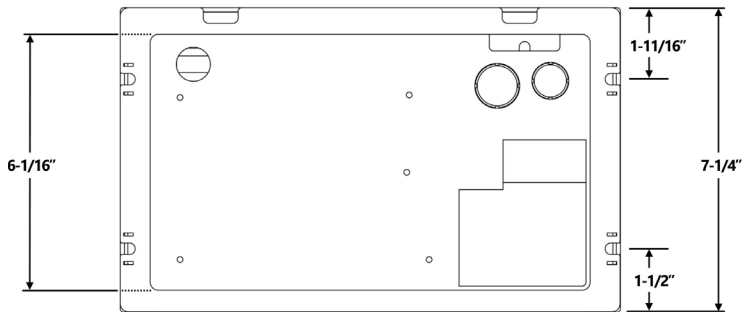

## Bottom View

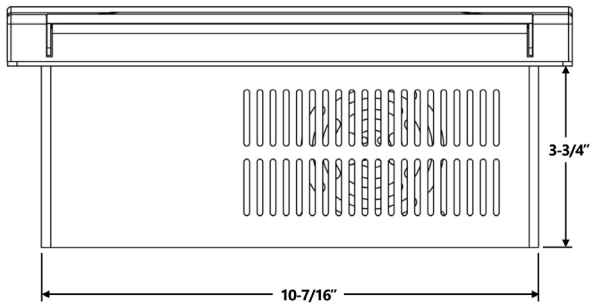
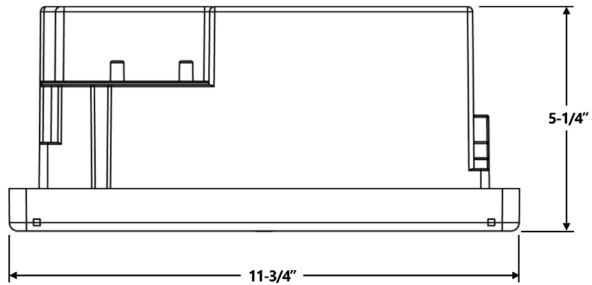

Figure 7

# WF-8735/8740 Power Center



## Top View



## Back View

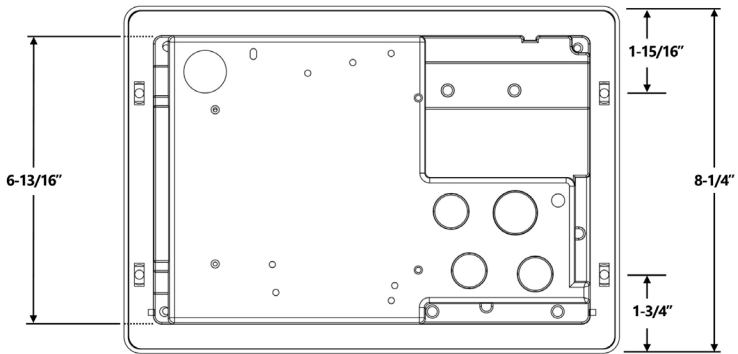

## Bottom View

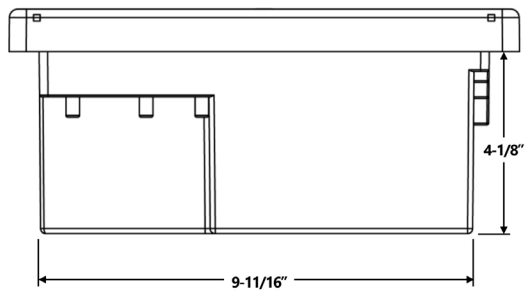

Figure 8



**THE HEARTBEAT OF TODAY'S RVs**

[WFCOELECTRONICS.COM](http://WFCOELECTRONICS.COM)